

GLOSS BLACK
POLYURETHANE
PAINT STANDARD.
OTHER COLORS &
POWDERCOATING
AVAILABLE.

SIDE VIEW
SCALE: 1/2" = 1'-0"

1

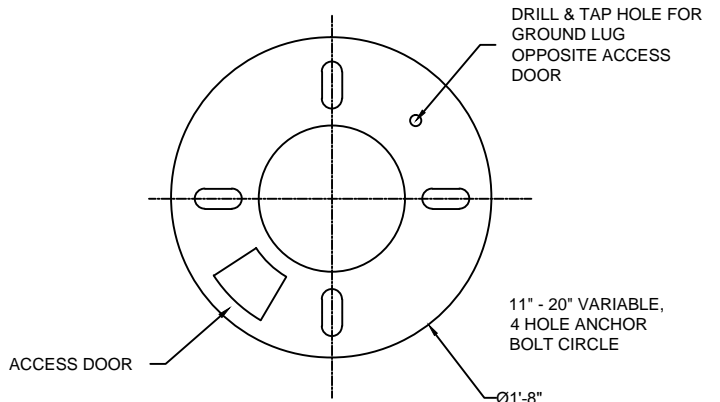

BOLT CIRCLE
SCALE: 1" = 1'-0"

2

NOTES

- 1. WIND SPEED 120 MPH
- 2. WIND LOADING 2.54
- 3. POLE WEIGHT 155 LBS.
- 4. WALL THICKNESS 0.125"

A	CREATED	JAH	05/18/17
B			
C			
REV:	DESCRIPTION:	BY:	DATE:

AMENDMENTS:

TITLE:	ALUMINUM-TAPERED-FLUTED	SCALE AT A4. 1/2"=1'-0"	DRAWN. JAH	CHECKED. XXX	REVISION. A
--------	-------------------------	----------------------------	---------------	-----------------	----------------

SITE:	WINDSOR-24	PART NO. AATF-2414	PROJECT NO. XX	DATE. 05/18/17
-------	------------	-----------------------	-------------------	-------------------



MAIN STREET LIGHTING

1080 INDUSTRIAL PKWY.
MEDINA, OH 44256
www.mainstreetlighting.com/